



**PLASTIMO RESCUE 7×50**  
**Binoculars with/without illuminated**  
**compass**

**Instructions for use and maintenance**



# Catalogue Index

1. General Overvi .....	1
2. Technical Specifications .....	1
3. Construction Specifications .....	1
4. How to use the Binoculars.....	3
5. Tripod Mounting .....	8
6. Binocular and accessories.....	7
7. Storage and Maintenance .....	8

## 1. General Overview

### 1.1 Main Character

7x50 binoculars is a water floating model with illuminated compass. It has two ranging tools. The eyepiece Reticle Scale and the Calculator Dial can be used to easily determine you distance from an object if its size is known, or vice versa. The optics is made excellently in order to give the viewer brightness, exacting image clarity and unparallel true color of the image. The user can have confidence whether it is being used in tour, viewing, boating, observation, or any other application.

**1.2 Model** 7x50 with compass

## 2. Technical Specification

### 2.1 Optical performance

Magnification: 7x

Field of view: 7.5° (396 ft. @ 1000 yards/131M @ 1000 Meters )

Exit pupil diameter: 6.8 MM

Exit pupil distance: 23 MM (Long eye relief for eyeglass wears)

Diopter adjusting range: -5~+5 DIOPTER

Interpupillary distance: 56~72 MM

Resolution: ≤5"

### 2.2 Size and mass

Size (length x width x height): 200 × 80 × 150mm

Weight

Binoculars: ≤0.9kg (1.98 lbs)

Complete product: ≤1.2 kg (2.65 lbs.)

## 3. Construction Specifications

### 3.1 Optical system

#### 3.1.1 Basic binoculars construction

Basic binoculars optical construction, as shown in figure 1, consist of (1) the objective lens, (2) the Porroprisms, (3)the reticle and (4)the eyepiece. The reticle (3) and compass projective system (5) are built into the right half of the binoculars body.

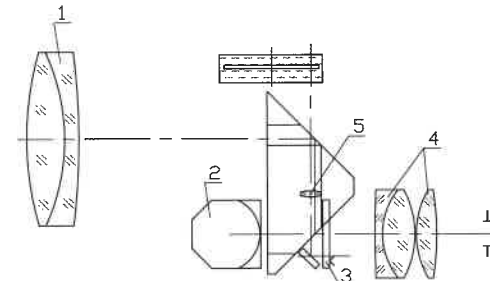

Fig 1

### 3.1.2 How Binoculars works

The light from the object or target you are looking at enters the binoculars through the Objective lens system (item 1, fig. 1). Due to the objective lens, the rays are converged to a upside down image. Then the light rays of the image pass through the prism system (known as the Porroprism) (item 2, fig. 1), and are reversed to erect image at the reticle (item 3, fig. 1) just as you see by eyes. This image is magnified by eyepieces (item 4, fig. 1), so that the observer can now see the distant object.

#### 3.1.3 Reticule Scale (See Fig. 3)

There are vertical and horizontal lines on the reticule 3. Each small division on both vertical and horizontal lines represents 5 mils and each big division represents 10 mils (one perigon=6400 mils).

### 3.2 Body assembly (Fig. 2)

The binoculars consists of identical two telescopes. A right side and a left side. Each half consists of (1) eyepiece, (2) main binocular body housing the Porroprism assembly and (3) objective. Item (4) is the connecting shaft holding both halves of the binoculars. Item (5) is a interpupillary scale, its range from 56 mm to 72 mm. Item (6) are diopter adjustment rings, which have diopter index marks. Each graduation represents one diopter. Item (7) are the rubber fold-down eyecups. Item (8) is the Calculator Dial. Item (9) is the compass illuminated window. Item (10) is switch for illuminating the compass. Item (11) is the battery compartment. Item (12) is the dustproof cover for the objective lenses and item (13) is the dustproof cover for eyepieces.

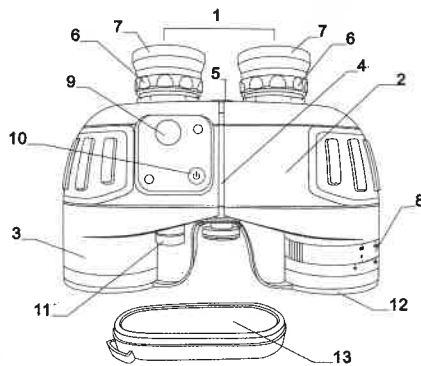

Fig. 2

## 4. How to use the binoculars

### 4.1 How to focus the binoculars

#### 4.1.1 Interpupillary adjustment

You must first adjust the binoculars so that each eye piece is adjusted to the distance between your eyes. This is done by putting the binocular in both hands and bending it until you can see a single circular image.

Note: the image will not be clear. You will adjust for clarity in the next step. You must first set the binoculars's interpupillary to fit your eyes. The setting for your eyes will be indicated on the interpupillary scale. Note this scale setting for quicker resetting later.

### 4.1.2 Rubber fold-down eyecups

This is a long eye relief binoculars. It allows the eyeglasses wearer to see a normal image without taking off glasses. These convenient eyecups fold down for using with glasses and fold up for using without glasses. lightly press eyecups, can fold down the eyecups easily.

### 4.1.3 Focusing

In order to get a clear image you must focus the binoculars. This model has two individual diopter adjustment rings on each telescope for you to adjust the optics to your individual eyes, you will need to adjust each eyepiece. After placing the binocular at your eyes and view an object, you will need to close your left eye. Rotate the right diopter adjustment rings until the object image appears sharp and clear in your right eye opening. Then open you left eye and close right eye, rotate the left diopter adjustment rings until the object image appears sharp and clear in your left eye opening. Then can get a perfect viewing.

To focus on other objects, repeat the same operation.

If you share your binoculars with another person note the diopter index mark setting at the base of the eyepieces first. Then you can simply return the eyepieces to those setting when you next use (with out adjustments) the binoculars to view an object at the same distance.

## 4.2 How to use the reticle and calculator dial as measuring devices

### 4.2.1 What is View Angle

View Angle of an object (or outboard of two objects) is the angle between the rays from telescope to its edges. Usually, this angle is measured at horizontal or vertical direction, and define it Horizontal View Angle and Vertical Angle.

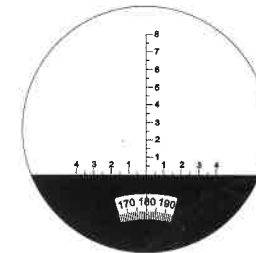

Fig. 3

A mil's reticle (fig.3) that has horizontal or vertical scale can measure the View angle of an object.

### 4.2.2 How to measure the Horizontal View Angle

4.2.2. A. When the Horizontal View Angle is smaller than the horizontal scale range (-40~+40 mils) inside the binoculars, aim one edge of the object at a horizontal scale line (the center or the outmost line are selected according to the image size of object usually) and read its value. Then read the value of the scale at which another edge was located. Plus this two value, the sum value is the measured Horizontal View Angle. As shown in fig 4, the Horizontal View Angle of the target (sailboat) is 2 decade miles (20 miles), and the Horizontal View Angle between the targets (p-p) is 8 decade miles (80mils).

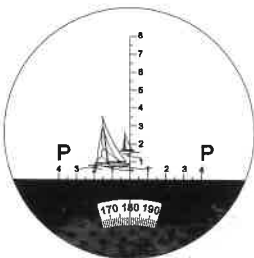

Fig. 4

**4.2.2.B.** When the Horizontal View Angle is bigger than the horizontal scale range (-40~+40 mils), a vertical line splits (for example: mast, chimney etc.) on the object can be selected to make the necessary estimated measurements in a step by step fashion. The sum of the value from each step is used to obtain the measured value. As shown in fig 5, the azimuth of target (cruiser) is 130 mils (60+70=130).

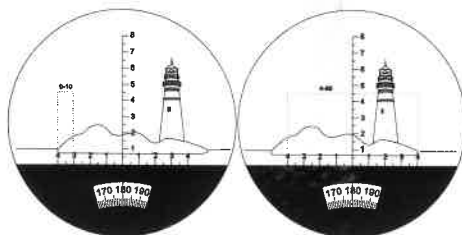

Fig. 5

#### 4.2.3 How to measure the Vertical View Angle

**4.2.3.A.** Vertical View Angle measurement is similar to measuring the Horizontal View Angle. When the Vertical View Angle measurement is small, aim the cross center of reticle at lower part of the object, read the scale value at the top of the object. As shown in fig 6, the angle included between the upper and lower parts of the target (lighthouse) is 6 decade mils (60mils).



Fig. 6

**4.2.3.B.** when the Vertical View Angle is larger than the vertical scale range (80 mils), it can be measured in steps and the angle can be obtained by summing up the value of each step. (The process will be similar to the one that is discussed in the linear measurements in 4.2.2 B above.)

#### 4.2.4 How to use the reticle to measure distance

The distance measurement of a target can be calculated by using the mil reticule. (Fig 7)

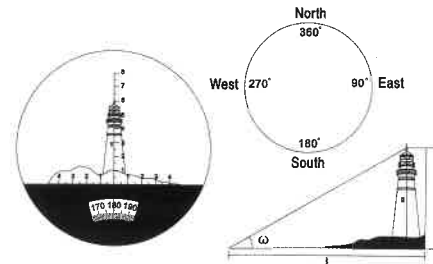

Fig. 7

The formula of distance measurement:  $L \text{ (km)} = H \text{ (m)}/\omega$

L — the distance between the observer and the object (km)

H — the height of the object (m)

$\omega$  — the View angle of the object measured with the reticule of binoculars (mil).

When measure the distance, first, estimate the width or height of the object, then measure the View Angle of the object. According, you can calculate the distance between the observer and the object using the formula.

For example:

There is an adult whose height is 1.70m. ( $H = 1.70\text{m}$ )

The Vertical View Angle of the adult is 4 decade mils (40mils)

$$L = H/\omega = 1.7/40 = 0.0425\text{km} = 42.5\text{m}$$

Therefore: the distance between the observer and the adult is 42.5m.

#### 4.2.5 How to use the Calculator Dial

The Calculator Dial can be used to determine distance quickly and easily without calculation. The Calculator Dial includes a triangular Angle Index Mark marked "ANGLE", a rotational Active Ring and a Fixed Scale marked "DISTANCE". There are two scales in the Active Ring, one above is View Angle scale and another is Size Scale marked "OBJECT SIZE".

First, measure the View Angle value of an object, and rotate the Active Ring and place this value at the Angle Index Mark. Then, find the division indicating the size of the object, it indicate a point at the Fixed Scale, look at the Fixed Scale, the distance is shown at that point on the Fix Scale.

For example: See fig 8. You observe a light house and its measured Vertical View Angle is 6 decade mils, you need rotate the Active Ring and place the division marked "6" in the View Scale at the Angle Index Mark. Its assuming high is 12m, the division marked "12" in the Size Scale point the division marked "200" in the Fixed Scale. This tell us that the lighthouse's distance is 200m from us.

The Size Scale and Fix scale of Calculator Dial are in a "ratio" to each other. When you observing object is too large or too small, you can zoom it tenfold or discretionarily, and zoom measuring result in the same way. Thus, you can get more convenience, specially, when you aren't familiar with diversified units.

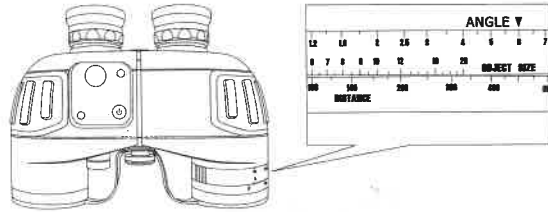

Fig. 8

#### 4.2.6. How to measure an object's size (height and width) using

According to the formula for distance measurement, you can calculate the height using:

$$H = L \times \omega.$$

When measuring the size, you first estimate the distance to the object, then measure the View Angle. With these measurements, you can calculate the height of the target using the formula.

For example:

the distance is 0.6km between the observer and the object. You can measure that the Horizontal View Angle is 6 decade mils(60mils) and the Vertical View Angle is 3 decade(30mils). So, using the formula you can get:

$$\text{The height: } H = 0.6 \times 30 = 18\text{m}$$

$$\text{The width: } h = 0.6 \times 60 = 36\text{m}$$

#### 4.3 How to use the compass

The azimuth angle can be measured through the compass built into the right half of the body. It shows the azimuth of the object relative to the observer. Each graduation of the compass equals one degree of angle. When the object lies in the north from you, the compass shows 0(degree) .And it will increase when you turn clockwise. 90°means the object lies in the east from you, 180°means the south and 270°means the west.

In order to insure precise angle measurements, the binoculars should be kept horizontal and level when reading the compass. The object should lie in the middle of the reticle.

The graduations of the compass need to be illuminated for convenient viewing when there is not sufficient daylight to illuminate the compass dial. (Do not use the battery operated internal illuminating system when the outside viewing conditions are bright enough to see the compass dial and marking clearly.) Press the illuminator button, the compass scale will be illuminated in red light for easy viewing.

#### 4.4 Changing the batteries

The batteries for the compass will be exhausted if the internal lighting system has been used long periods of time. Batteries can also become weak if not used for a prolong period of time. If so, open the battery cover and replace with fresh batteries.

Batteries are included and pre-installed in your binocular. When it becomes necessary to replace them, unscrew the battery cover with a coin or screwdriver and replace with the same type. Be sure to install the batteries in the same direction as the originals, with the flat positive (+) side facing up towards the cover on both batteries as shown(fig.9).Screw the battery cover back on tightly and press the compass illuminator button to test light-a glow should be visible around the compass(you may need to cover the right objective lens if you are outside in bright light).

**Attention:** The two batteries should be replaced at the same time. The batteries should be taken out if the binoculars will not be used for a long time. Batteries left in the binoculars for prolong periods of time without being used may leak and cause damage to the binoculars.

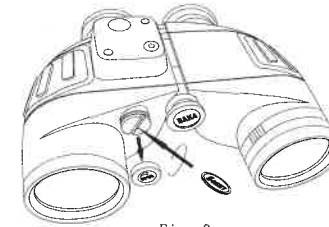

Fig. 9

#### 5. Tripod Mounting

A threaded socket for tripod attachment is located at the base of the binoculars hinge (fig.10) Insert a binoculars tripod adapter (Bushnell #161001CM or similar), and attach your tripod screw to the base of the adapter.

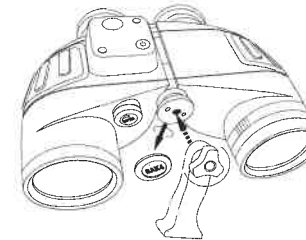

Fig. 10

#### 6. Binoculars and accessories

7× binoculars	1 pc
Carrying strip	1 pc
Eyepiece cap	1 pc
Brush	1 pc
Lens cleaning cloth	1 pc
Instructions	1 copy
Soft case with carrying strap	1 pc

#### 7. Storage and maintenance

Binoculars are precision optical instrument. It should be carefully handled and maintained in order to keep it in good working order.

##### 7.1 General Maintenance

**7.1.1 Lenses:** Always clean the lenses after each use and before you put it back in it's carrying case.

After each use, brush any dust or dirt of the lenses with the special optical brush that came with your binocular. After brushing, gently wipe each of the lenses with the special optical cloth. Never use your finger to wipe the lenses as body oil will get on the lenses possibly damaging them. Never use anything to wipe your lenses except special optical cloths. Always keep your optical cloth in the binoculars case for easy access for cleaning.

**7.1.2** Although the eyepieces are made to turn for individual eye diopter adjustments, do not turn them beyond the factory set stop. Forcing it beyond this point will damage the eyepiece optics and make the binoculars unworkable.

**7.1.3** After using, always remember turn the diopter adjustment to its "0" position to avoid any damage of the ocular system in case of accident.

**7.1.4** Avoid any extreme shaking or dropping of the binoculars. This may damage the internal optics and prisms. Store the binocular in a dry and well-ventilated place.

**7.2 Maintenance** If you find that the binoculars not working correctly, do not try to repair it yourself. Trying to repair it yourself may void any warranty you have on the binoculars. Always, take or send it to a professional binoculars repair station. If one is not readily available, then send it back to the factory.